

# ASSEMBLY INSTRUCTIONS

# 300 lb Weight Capacity







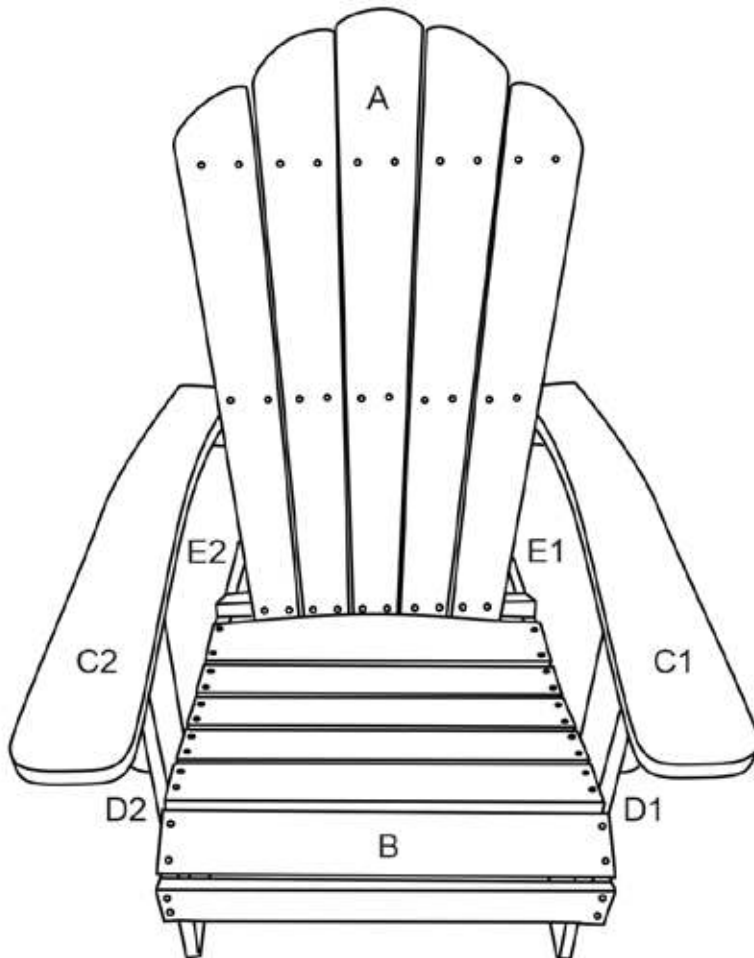





- ADCHAIR1 (BLACK/DRIFTWOOD)
- ADCHAIR3 (BLACK/TAN)
- ADCHAIR5 (WHITE/DRIFTWOOD)

- ADCHAIR2 (BLACK/GREY)
- ADCHAIR4 (WHITE/TAN)

1. Attach Back (#A) and Seat (#B) using Bolt-M6x40mm (#AA).
2. Attach Left Vertical Back Support (#E1) to Left Armrest (#C1) using Bolt-M6x35mm (#BB).
3. Attach Left Front Leg (#D1) to Left Armrest (#C1) using Bolt-M6x35mm (#BB).
4. Attach Left Vertical Back Support (#E1) to Seat (#B) using Bolt-M6x30mm (#CC).
5. Attach Left Front Leg (#D1) to Seat (#B) using Bolt-M6x40mm (#AA).
6. Attach Right Vertical Back Support (#E2) to Right Armrest (#C2) using Bolt-M6x35mm (#BB).
7. Attach Right Front Leg (#D2) to Right Armrest (#C2) using Bolt-M6x35mm (#BB).
8. Attach Right Vertical Back Support (#E2) to Seat (#B) using Bolt-M6x30mm (#CC).
9. Attach Right Front Leg (#D2) to Seat (#B) using Bolt-M6x40mm (#AA).
10. Attach Left Vertical Back Support (#E1) with Right Vertical Back Support (#E2) to Back (#A) using Bolt-M6x40mm (#AA).
11. Hand tighten all bolts in place, then tighten with Hex Wrench (#EE) once fully assembled.



## PARTS LIST

<b>A</b>  Back x1	<b>B</b>  Seat x1
<b>C1</b>  Left Armrest x1	<b>C2</b>  Right Armrest x1
<b>D1</b>  Left Front Leg x1	<b>D2</b>  Right Front Leg x1
<b>E1</b>  Left Vertical Back Support x1	<b>E2</b>  Right Vertical Back Support x1
<b>AA</b>  Bolt - M6x40mm x12	<b>BB</b>  Bolt - M6x35mm x4
<b>CC</b>  Bolt - M6x30mm x4	<b>EE</b>  Hex Wrench x1

# ASSEMBLY INSTRUCTIONS

NOTE: Hand tighten all bolts in place, then tighten with hex wrench when fully assembled.

