

SSWMFDT

Stainless Steel

Wall Mount Fold Down Work Table

Assembly Instructions

Max Weight Capacity = 110 Lbs



READ ALL INSTRUCTIONS AND WARNINGS BEFORE USING THIS PRODUCT.

This manual provides important information on proper operation & maintenance. Every effort has been made to ensure the accuracy of this manual. These instructions are not meant to cover every possible condition and situation that may occur. We reserve the right to change this product at any time without prior notice.



IF THERE IS ANY QUESTION ABOUT A CONDITION BEING SAFE OR UNSAFE, DO NOT USE THIS PRODUCT!

DO NOT RETURN THIS PRODUCT TO THE RETAILER - CONTACT CUSTOMER SERVICE.

If you experience a problem, have questions or need parts for this product, visit our website <http://www.sportsmanseriesbrand.com> or call Customer Service at 1-888-287-6981, Monday-Friday, 8 AM - 4 PM Central Time. A copy of the sales receipt is required.

KEEP MANUAL, SALES RECEIPT & APPLICABLE WARRANTY FOR REFERENCE PARTS LIST

		
Shelf - 1 Piece	Side Bracket - 2 Pieces	Back Panel - 1 Piece
		
M4 Screws - 4 Pieces	M8 Screws - 4 Pieces	M8 Nut - 4 Pieces

	
Hex Key	Spanner
1	1

Check all packaging materials for any small parts that may have come loose during shipping. Before assembly, locate and identify all parts.

ASSEMBLY INSTRUCTION

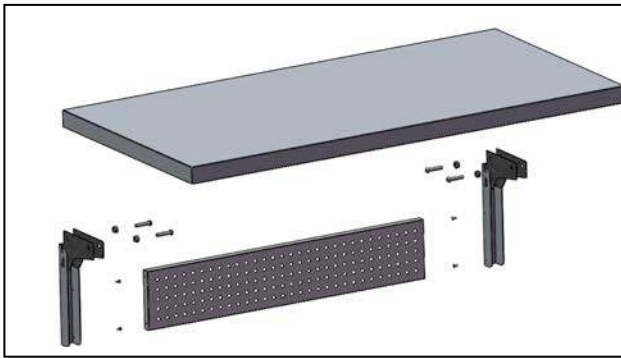

WARNING: BE PREPARED FOR TEAM LIFT WHEN ASSEMBLING/MOVING HEAVY TABLE.

WARNING: SHARP EDGES CAN CAUSE INJURY. USE CAUTION WHEN ASSEMBLING/MOVING TABLE.

WARNING: DO NOT SIT OR STAND ON TABLE OR SHELF.

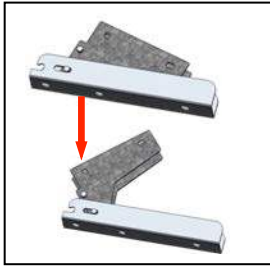

Fig 1



Fig 2

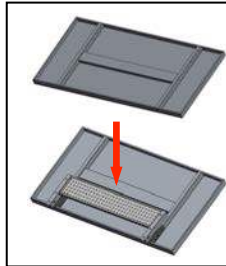

Fig 3



Fig 4



Fig 5

1. Remove all protective film, taking care to avoid scratching the surface.
2. Unfold both side brackets [Fig.1] , then attach them to the back panel using M4 screws [Fig. 2]
3. Position assembled parts onto wall to determine where to drill holes for installing brackets.
4. Attach the assembled parts to the shelf using M8 screws and nuts [Fig.3]
5. Install the shelf onto the wall through the top hole of the bracket using expansion screws. (Expansion screws not supplied) [Fig.4]
6. Unfold the shelf [Fig.5, Fig. 5A] , attach expansion screws onto the wall [Fig. 6, Fig 6A]
7. Rotate the shelf into locked and unlocked position by aligning with pins. [Fig.7]

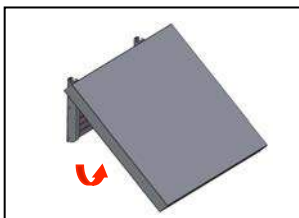

Fig 5A



Fig 6

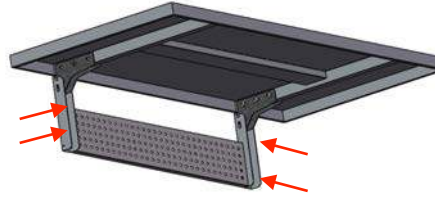

Fig 6A

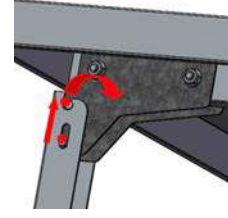

Fig 7

Safety Tips

- Use caution when cleaning or handling to prevent risk of injury from exposed metal edges.
- Do not overload the table or shelf.

Cleaning

- Before use, remove protective film then clean the table.
- Clean the table using a cleaning agent suitable for use with stainless steel and galvanized surfaces.
- Always remove cleaning agent residues, as this can discolor the surface.
- Never leave any surface damp as this may cause discoloration. Wipe dry thoroughly.