

ITEM # SWTB36
Assembly Instructions
Max Weight Capacity 300 Lb



READ ALL INSTRUCTIONS AND WARNINGS BEFORE USING THIS PRODUCT.

This manual provides important information on proper operation & maintenance. Every effort has been made to ensure the accuracy of this manual. These instructions are not meant to cover every possible condition and situation that may occur. We reserve the right to change this product at any time without prior notice.

**IF THERE IS ANY QUESTION ABOUT A CONDITION BEING SAFE OR UNSAFE,
DO NOT USE THIS PRODUCT!**

Questions? Problems? CALL CUSTOMER SERVICE FOR SERVICE, PARTS & TECHNICAL SUPPORT. If you experience a problem, have questions or need parts for this product, visit our website













<http://www.amerihomebrand.com> or call **Customer Service** at 1-636-532-9888, Monday-Friday,

8 AM - 4 PM Central Time, or email : info@amerihomebrand.com. A copy of the sales receipt is required.

KEEP MANUAL, SALES RECEIPT & WARRANTY FOR FUTURE REFERENCE

HARDWARE

1. Identify and locate all hardware components listed below.

<p>A</p>  <p>1 PC</p>	<p>B</p>  <p>1 PC</p>	<p>C</p>  <p>1 PC</p>	<p>D</p>  <p>4 PCS</p>	<p>E</p>  <p>4 PCS</p>	<p>F</p>  <p>1 PC</p>	<p>G</p>  <p>1 PC</p>	<p>H</p>  <p>1 PC</p>	<p>I</p>  <p>8 PCS</p>
<p>J</p>  <p>1PC</p>	<p>K</p>  <p>1 PC</p>	<p>L</p>  <p>1 PC</p>						

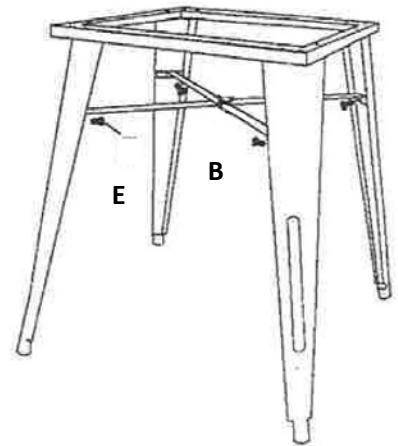
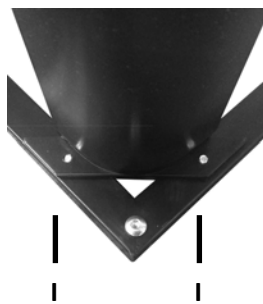
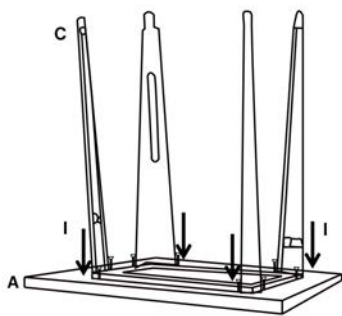

2. Attach each Table Leg (D) to Table Top Frame (C) using 8 pieces medium screws (I).

3. Attach 1 piece X-support (B) using 4 pieces small screws (E).

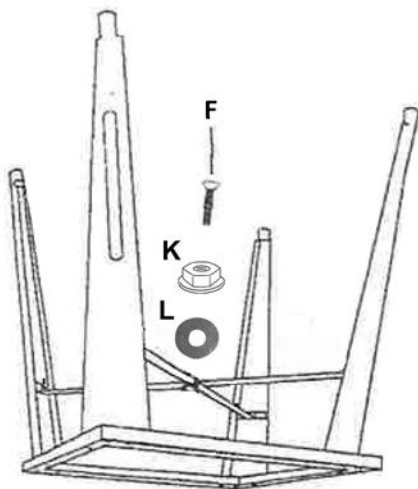
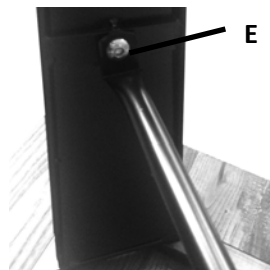

4. Attach X-support (B) using 1 piece screw (F), washer (L) and nut (K).

5. When all pieces are attached, tighten each screw securely.